

MPM486

Operation Manual

V2.0



MICROSENSOR



Thank you very much for selecting Micro Sensor's product, please take some time to read this operation manual very carefully before using the product..

1 Introduction

MPM486 with HART pressure transmitter is an intelligent pressure measuring unit with 2-wire, analog and digital signal outputs. It has a good performance with digitally temperature compensation and non-linearity correction, 4 bytes and a half LCD display, according with HART communication protocol, it is available with long-distance operation.

The transmitter can be widely used in pressure measurements and industry process controls system requiring BUS operation with HART protocol in the fields of petroleum ,chemo-industry, electric power and paper making etc, The unit can be compatible with the similar products and suitable for applications requiring two wire analog signal transmission or long-distance adjustment via MS-HART handholding programmer. Before using MPM486 transmitter, please read carefully this manual and operating accordingly.

2 Specification

Pressure Range: 0kPa ~20kPa...100MPa

Overpressure: 1.5 times FS or 110MPa (Min. value is valid)

Pressure Type: Gauge, Absolute or Sealed

Accuracy: $\pm 0.1\%FS$ (Typ) $\pm 0.25\%FS$ (Max)

Temperature error: $\pm 0.25\%FS$ (Within compensated temperature range)

Annual stability : $\leq \pm 0.25\%FS$ /year

Compensated temperature range: $-10^{\circ}C \sim 70^{\circ}C$

Operation Temperature range: $-20^{\circ}\text{C}\sim 80^{\circ}\text{C}$

Storage temperature range: $-40^{\circ}\text{C}\sim 85^{\circ}\text{C}$

Power supply: $12\text{V}\sim 36\text{VDC}$

Output: $4\sim 20\text{mA}$ with HART protocol digital communication

Display: LCD Display, Two/Three keys controls

Damp: $0\text{s}\sim 32\text{s}$

Load: $(U-12\text{V})/0.02\Omega$

Insulation: $100\text{M}\Omega / 50\text{V}$

Endurance: 1×10^7 pressure cycle, $0\%\text{FS}\sim 100\%\text{FS}$, @ 25°C

Vibration: 20g ($20\sim 5000$)Hz

Shock: 20g 11ms

Protection: IP65

Sealing ring: O Ring Viton

Weight: About 1.7kg

3 Outline dimension(Unit:mm)

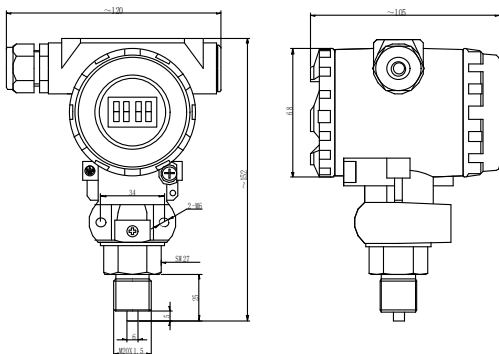

Figure 3-1

4 Electronic connection.

4.1 Electrical Definitions

The Supply/Signal terminal locates inside electronic housing. When making connection, please open the “transmitter” cover firstly, the terminal’s definition see as the Figure4.1-1, the left terminal marked with “+A or -B” is for supply/signal.

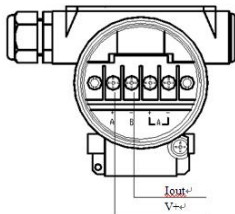

Figure4.1-1

Power is supplied by the signal wires. The Signal/Supply share one terminal(2wires, no additional supply wire).While you make connection, please take very carefully to make right connection: the anode of Supply wires connecting with the anode of Supply terminal “+A” on the left, Signal I-out connecting the signal terminal “-B”.

Be sure the Supply & Signal wires DO NOT connecting with the “TEST” terminal. Otherwise, it will make the transmitter output loop short and cause the loop parts turnoff. In case that happens, you could take the emergency method to short the TEST and Common terminals to recover the normal operation of the transmitter.

The signal wire do not need to use a shield cable, the twisted-pair couple wire can get the best effect. Please DO NOT let the signal wire share the same wire/cable allocation pipe or slot with other equipments power supply wires, and the signal wire NOT close to the high-power equipments. Using sealing

element to seal the passing-hole after connecting the wires. In case you can't find a sealing element on site, please installing the transmitter with the wires hole face down to prevent from entering water. The signal wire can be floating on the ground or any one point in the signal loop grounded. The transmitter housing grounded or not grounded are both okay.

The stability of supply voltage for transmitter is not strict, even if the voltage wave around 1V, the influence on output signal is very small or can be ignored. The transmitter is capacitive coupled grounded, while you are checking the insulation resistance, take care NOT use high volts megohm meter, only max 100V. megohm meter can be allowed for checking the circuits. The maximum current for the transmitter with 4~20mADC output will not exceed 22mA DC.

4.2 Remote control

a) Connecting with the computer

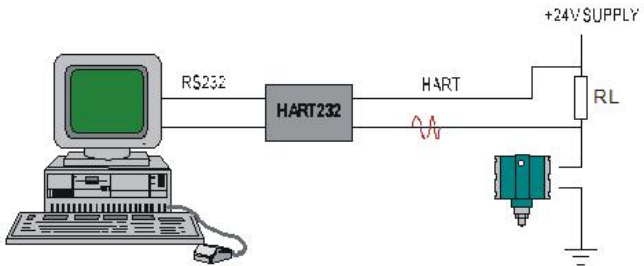

The user can be easily through HART-CONFIG TOOL to connect with HART intelligent pressure transmitter by HART/RS232 interface to realize the

configuration, calibration, local controls and maintenance of HART protocol intelligent transmitter.

b) Connecting with the hand-holder

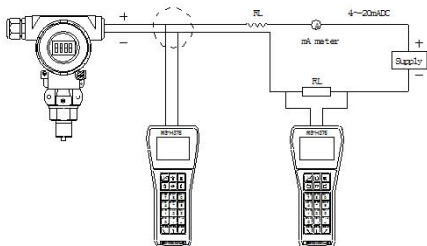

By connecting with MS-H375 HART hand-holder to realize the configuration, calibration, local controls and maintenance of HART protocol intelligent transmitter.

5 Display

Customers can use configuration software to set the volume and the decimal point of LCD display. Referring to the words of “meter configuration” to “output” of configuration software.

LCD allows the double volumes displaying. The possible setting volume includes current, main volume and its percentage; every volume is possible to set the decimal position of displaying: 0. 1. 2. 3.

If the two displaying volume are same, LCD only displays one; otherwise, LCD will display the both volumes one after one in 3s internally,

LCD all information display see Figure 5-1

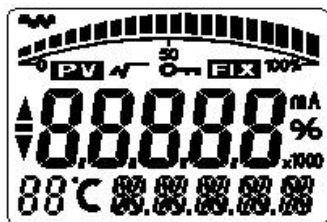

Figure 5-1

Current display see Figure 5-2

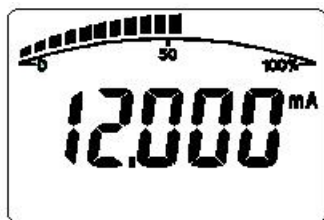

Figure 5-2

Main volume percentage display see Figure 4-3

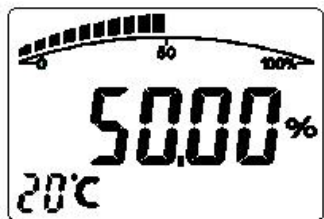

Figure 5-3

Main volume display see Figure 5-4

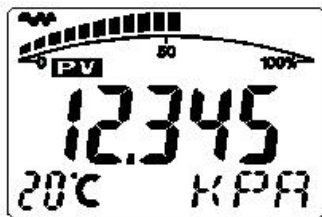





Figure 5-4

Other display notes:

- In the communication state, the left-up corner of LCD flash .
- For the rooting output, LCD display .
- For fixed current output, LCD display **FIX**.
- If you start the writing protection, LCD display .
- If you want to let temperature displayed, except the normal display information, LCD left-down display the temperature“88”, below-19°C or over 99°C display .

6 Local Adjustment

It is possible to set the unit, range, damp etc and adjust the zero, zero and span elevation functions, also you can look above volumes to press the keys.

6.1 key operation

It supports “double keys” and “three keys” operation. (magnetic stick adjustment is same as double keys pressing operation)

In “double keys” operation: Z key is for entering the volume setting and moving cursor; S key is for entering volume setting, adding and storing data.

In “three keys” operation: Z key is for entering the volume setting and moving cursor; S key is for entering volume setting, adding and storing data. M key is for storing data.

6.2 Data Set

While the left-down corner “88” display 1~7, it shows that the transmitter is in the state of local adjustment, now you can use keys to input the pass code, adjust data or elevation.

In setting, “S” key is for adjusting data and decimal point, “Z” key is for moving, “M” key is for storing.

Setting procedure:

1. Press down S key will enter data setting, then symbol starts flashing and you can change symbol.
2. If press down S key again, you can exchange data's + and - (“▲” means +)
3. Press down Z key, the first number begins to flash; now you can set the number. If you keep pressing down or pressing down S key repeatedly, the number will display sequentially.
4. Press down Z key again, you can set the second to the fifth number sequentially, the way is as the same as the step 3.
5. After setting the fifth number, press down Z key to set the decimal point. Four decimal points start to flash at the same time and you can set decimal point position. Now, press down S key, the decimal point position change sequentially.

6. After setting decimal point, press down Z key, the left-down arrows flash, now you can store your setting.
7. Press down S key to store setting; press down Z key, symbols bit begins to flash and you can start the new setting programmed.

Notice: If it is the “three keys” operation, during the setting procedure, you can press down M key at any time to store setting quickly. If not, you have to wait for the next down arrows flashing to store your settings.

6.3 Local Adjustment

6.3.1 Data setting

In local adjustment, LCD left-down “88” will show setting data types, the corresponding relations:

Left-down “88”show	Setting data
0 or null	Normal display
1	Setting pass code
2	Setting units
3	Setting Range Down Limit
4	Setting Range Up Limit
5	Setting Damp
6	Adjusting Main volume to Zero
7	Zero and Span elevation

In the normal display state, press down Z key will enter the configuration data setting, configuration data setting process see Figure 6.3-1.

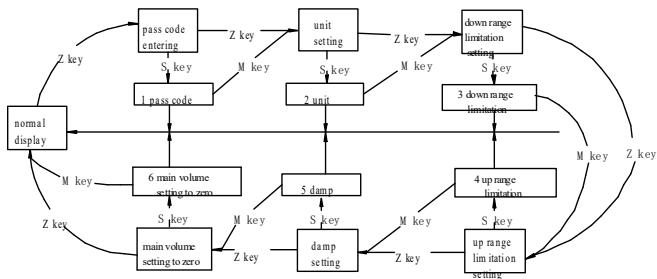

Figure 6.3-1

Note:

- In double key operation, while “▼” flashes, press down S key to realize M key function.
- The pass code of configuration data setting is 00002, when it is correct, you can start data setting, if not, it will be back to normal display.
- If the setting data is over the limitation, LCD display “OVER”, then press down S key or Z key to reset.
- While entering configuration data setting, if no press down in two minutes, it will be back automatically.
- When finishing the setting and going back the normal display state, if you press down Z key again in ten seconds, it will restart the setting and ignore the pass code procedure.

In 5.2 data setting, you can do the pass code entering, the up and down range limitation and damp setting, but as for unit setting and main volume setting zero,

you will follow the below procedure:

6.3.2 Unit setting:

Unit setting procedure sees Figure 6.3-2. Right-down corner of LCD display the unit what you select.

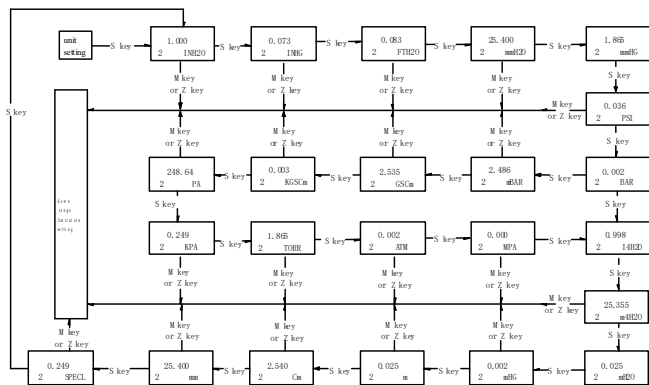

Figure 6.3-2

Note:

- Display unit “I4H2O” means: inch water column at 4°C;
- Display unit “m4H2O” means: m water column at 4°C.

Main volume setting to zero:

Procedure sees Figure 6.3-3.

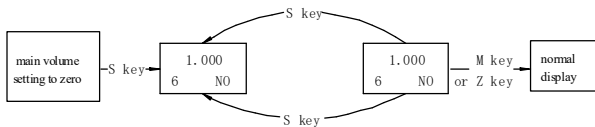

Figure 6.3-3

1. configuration data over looking

In the normal display state, press down S key can over look data quickly, the looking order is as the same as data setting procedure Figures.

2. zero and span elevation

In the normal display state, press down Z and S key at the same time, then entering the zero and span elevation state, the procedure see Figure 5.3-4.

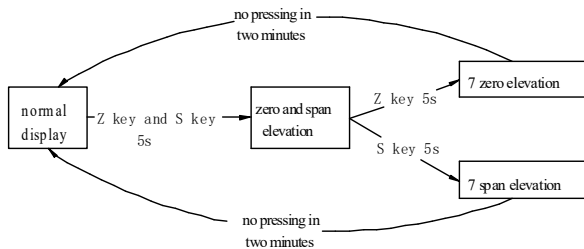

Fi

Figure 6.3-4.

7 Notice

1. Before operation, please read this operation manual very carefully, and make right connection accordingly.

2. If no standard pressure source, please DO NOT calibrates the transmitter; if you have to calibrate it, let a professional engineer do it.
3. DO NOT touch the diaphragm by your finger or a sharp tool, it will damage the sensor.
4. If the transmitter application site is near strong interfere, be sure the electronic housing grounded well.

8 Warranty

Within one year from the delivery date, we shall repair or replace the instrument with any faults caused by parts and its manufacturing process, but the go-and-back transportation fees will be bored by users.

attachment: configuration adjusting software note

HART Intelligent Transmitter Configuration Adjustment

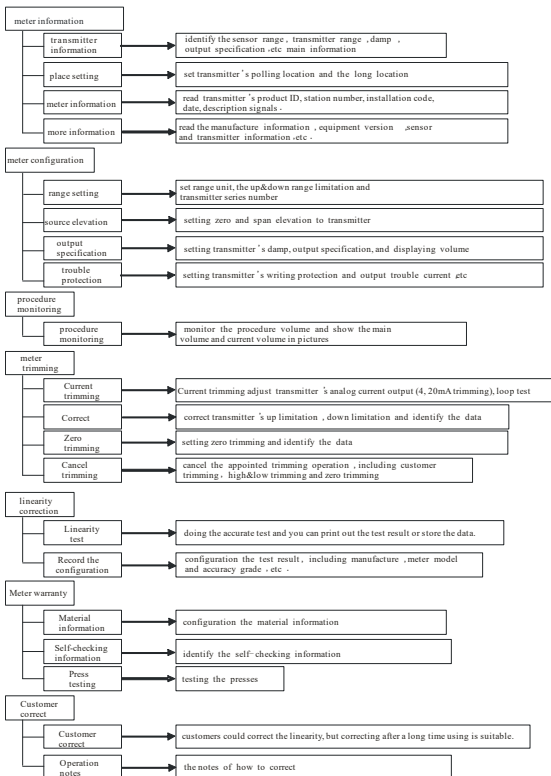

www.microsensor.cn



MICRO SENSOR CO.,LTD.

ADD:No. 18 Ying Da Road, Baoji City, Shaanxi Province

Tel: +86-(0)917-3600739/909 400 860 0606

Fax:0917-3600755

E-mail:sales@microsensor.cn